



# [CINE]micro<sup>®</sup>

**OWNER'S MANUAL & INSTALL GUIDE**

## 5.1 HOME THEATER SYSTEM



Thank you for choosing Phase Technology<sup>®</sup> speakers. We know there are a wide variety of choices available today, and we sincerely appreciate your purchase of our product. Phase Technology speakers are built to exacting standards and will provide many years of listening enjoyment.

Our speakers are the result of over five decades of designing and manufacturing. We hold many key patents in loudspeaker technology including the soft-dome tweeter. Our mission, our passion is to constantly advance the art and science of accurate audio reproduction. Our dedication insures your new speakers will accurately reproduce all the impact, detail and delicacy of today's digital technology.

Regardless of application, serious audiophile listening or home theater, we recommend that you take the time to read this manual thoroughly before connecting speakers to your amplifier or receiver. In the highly unlikely event that you should experience a problem with set-up or operation, please contact one of our authorized dealers for assistance, or contact us directly.

Phase Technology Corporation  
8005 W. 110th St., Suite 208  
Overland Park, KS 66210  
855.663.5600 (Domestic)  
+1.913.663.5600 (International)  
Fax: 913.663.3200

### **[CINEMICRO<sup>®</sup> ONE FEATURES]**

- Includes four (4) CineMicro<sup>®</sup> Satellites, One (1) CineMicro<sup>®</sup> Center, and One (1) HV81 8" Long Throw Subwoofer
- Sleek, all wood, Gloss Black Cabinets (Satellites & Center) with a Black Ash Subwoofer
- Absolute Phase<sup>®</sup> Crossovers, engineered to route sound to a particular driver and that the particular driver will only produce the frequencies for which it was designed
- Easy-to-upgrade by adding Satellites and/or Subwoofers to turn system into 5.2 or 7.2 configuration

<b>SAFETY INSTRUCTIONS</b>	<b>3</b>
<b>GETTING STARTED AND PRECAUTIONARY NOTES</b>	<b>4</b>
<b>HOME THEATER SPEAKER PLACEMENT</b>	<b>4</b>
<b>SUBWOOFER PLACEMENT</b>	<b>5</b>
<b>SPEAKER CONNECTIONS</b>	<b>6</b>
<b>MOUNTING CINEMICRO ONE ON A WALL</b>	<b>7</b>
<b>TABLE TOP OR SHELF PLACEMENT</b>	<b>7</b>
<b>SUBWOOFER CONNECTIONS</b>	<b>7</b>
<b>AMPLIFIER SETUP AND BASS MANAGEMENT</b>	<b>8</b>
<b>SUBWOOFER AMPLIFIER PANEL</b>	<b>8</b>
<b>CARING FOR YOUR SPEAKERS</b>	<b>8</b>
<b>MAINTENANCE AND SERVICE</b>	<b>8</b>
<b>TROUBLESHOOTING</b>	<b>8</b>
<b>WARRANTY</b>	<b>9</b>
<b>SPECIFICATIONS</b>	<b>9</b>

## [SAFETY INSTRUCTIONS]

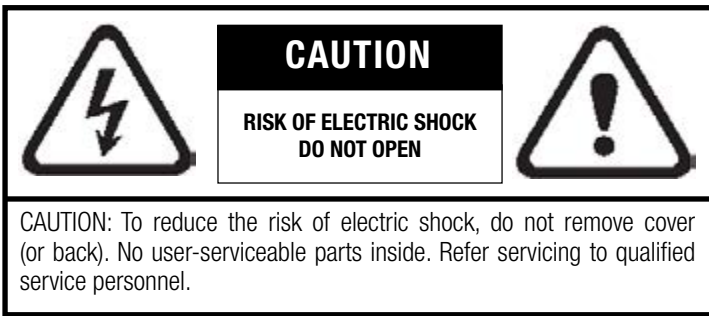

### Explanation of Graphical Symbols



The lightning flash with arrowhead symbol, within an equilateral triangle, is intended to alert you to the presence of un-insulated "dangerous voltage" within the product's enclosure that may be of sufficient magnitude to constitute a risk of electric shock to persons.



The exclamation point within an equilateral triangle is intended to alert you to the presence of important operating and maintenance (servicing) instructions in the literature accompanying the appliance.

**1. Read Instructions** - All the safety and operating instructions should be read before the appliance is operated.

**2. Retain Instructions** - The safety and operating instructions should be retained for future reference.

**3. Heed Warnings** - All warnings on the appliance and in the operating instructions should be adhered to.

**4. Follow Instructions** - All operating and other instructions should be followed.

**5. Water and Moisture** - The appliance should not be used near water - for example, near a bathtub, washbowl, kitchen sink, laundry tub, in a wet basement, or near a swimming pool, etc.

**6. Carts and Stands** - The appliance should be used only with a cart or stand that is recommended by the manufacturer.

### PORTABLE CART WARNING



**7. Wall or Ceiling Mounting** - The appliance should be mounted to a wall or ceiling only as recommended by the manufacturer.

**8. Ventilation** - The appliance should be situated so that its location or position does not interfere with its proper ventilation. For example, the appliance should not be situated on a bed, sofa, rug, or similar surface that may block the ventilation openings; or placed in a built-in installation, such as a bookcase or cabinet

that may impede the flow of air through the ventilation openings.

**9. Heat** - The appliance should be situated away from heat sources such as radiators, stoves, or other appliances that produce heat.

**10. Power Source** - The appliance should be connected to a power supply only of the type described in the operating instructions or as marked on the appliance.

**11. Power Cord Protection** - Power supply cords should be routed so that they are not likely to be walked on or pinched by items placed up or against them, paying particular attention to cords at plugs, convenience receptacles, and the point where they exit from the appliance.

**12. Cleaning** - The appliance should be cleaned only as recommended by the manufacturer.

**13. Nonuse Periods** - The power cord of the appliance should be unplugged from the outlet when left unused for a long period of time.

**14. Object and Liquid Entry** - Care should be taken so that neither objects fall nor liquids spill into the inside of the appliance.

**15. Damage Requiring Service** - The application should be serviced by qualified service personnel when:

- the power supply cord or the plug has been damaged,
- objects have fallen onto or liquid has been spilled into the appliance,
- the appliance has been exposed to rain,
- the appliance does not appear to operate normally or exhibits a marked change in performance, or
- the appliance has been dropped or the cabinet damaged.

**16. Servicing** - The user should not attempt to service the appliance beyond those means described in the operating instructions. All other servicing should be referred to qualified service personnel.

**17. Grounding or Polarization** - Precautions should be taken so that the grounding or polarization means of an appliance is not defeated.

### APPLICABLE FOR USA, CANADA OR WHERE APPROVED FOR USAGE

**CAUTION:** TO PREVENT ELECTRIC SHOCK, MATCH WIDE BLADE PLUG TO WIDE SLOT, INSERT FULLY.

**ATTENTION:** POUR EVITER LES CHOCS ELECTRIQUES, INTRODUIRE LA LAME LA PLUS LARGE DE LA FICHE DANS LA BORNE CORRESPONDANTE DE LA PRESE ET POUSSER JUSQU'AU FOND.

# [CINE]micro<sup>®</sup>



## **[GETTING STARTED AND PRECAUTIONARY NOTES]**

For proper connection and therefore full enjoyment of your new Phase Technology speakers, we encourage you to read this owners' manual thoroughly, even if you are very familiar with installing speakers and home entertainment equipment.

Speaker placement is very subjective. Placement follows the guidelines for the developers of multi-channel home entertainment systems, yet is also guided by personal preferences. The proper spacing, location and adjustment of front, rear and center-channel speakers as well as subwoofers are critical for complete enjoyment of your new speakers. This manual covers these topics thoroughly.

Before connecting your new speakers or other system components, turn the system power off and unplug your amplifier to avoid any possibility of damage from power surges or unbalanced loads before the system is properly connected.

Observe speaker polarity carefully! Every cable, speaker terminal and amplifier connection are clearly marked to show their positive (+) and negative (-) polarities. For ideal system performance, always connect the positive side of the cable (marked with a stripe, color and /or other indicator) to the positive terminals on your speakers and amplifier and the negative side of the cable to the negative terminals.

Amplifier selection is critical to your enjoyment of your new speakers. If you are considering upgrading your current component amplifier or multi-function receiver, we suggest purchasing as much power as your budget can afford. It will always be preferable to have an affordable high-powered model with fewer "bells and whistles" than a lower-powered model straining to operate near its power limits.

High volume settings that produce audible distortion – indicating an under-powered amplifier – could eventually damage your speakers and your amplifier.

Begin and end listening sessions at low volume levels so you will not power up your system the next time with possibly harmful high voltages. A damaging surge also could result if you change the input source (from FM tuner to CD player, for example) at high volume levels.

If you suspect that one channel of your amplifier has failed, have it repaired immediately by your dealer. Damage to your speakers could occur if you switch between the good and defective channels.

## **[HOME THEATER SPEAKER PLACEMENT]**

Today's digital multi-channel home theater technology has elevated the art of "surround sound" to reproduce the movie theater experience in your own home. Speaker requirements and placement are important when reproducing these multi-media effects.

Two front speakers (left and right), two surround speakers (left and right), a center-channel speaker, and a subwoofer define the minimum arrangement for multi-channel systems such as Dolby<sup>®</sup> Pro Logic, DTS<sup>®</sup>, Dolby<sup>®</sup> Digital, Dolby<sup>®</sup> TrueHD and DTS<sup>®</sup> HD Master Audio. Your Phase Velocity speaker has been designed for optimal performance with these systems. You will get the best results if you use the same type of speakers throughout your home theater.

Placement of speakers in your room will impact the final listening experience. To position your speakers, there are some general guidelines that take room size, shape, and fixtures and furnishings into account. Use the following illustrations as a general guide for speaker placement in a typical home theater system.

Front speakers should be placed 6-8 feet apart (or on the sides of your screen if your screen is wider) to fully separate the left and right channels. Whether placed on speaker stands, on shelves, or on the wall your speakers should be at or slightly above ear level.

Rear surround speakers also should be placed at or slightly above your listening position for the best reproduction of surround sound effects. Ideally, they should be facing into your favorite listening position from either side of the room.

Center speaker placement should be, if possible, directly on top of or under your TV monitor or projection TV screen, in a horizontal orientation, centered with your video screen. This correctly positions the critical sound track information (usually dialogue) that filmmakers direct to the center channel.

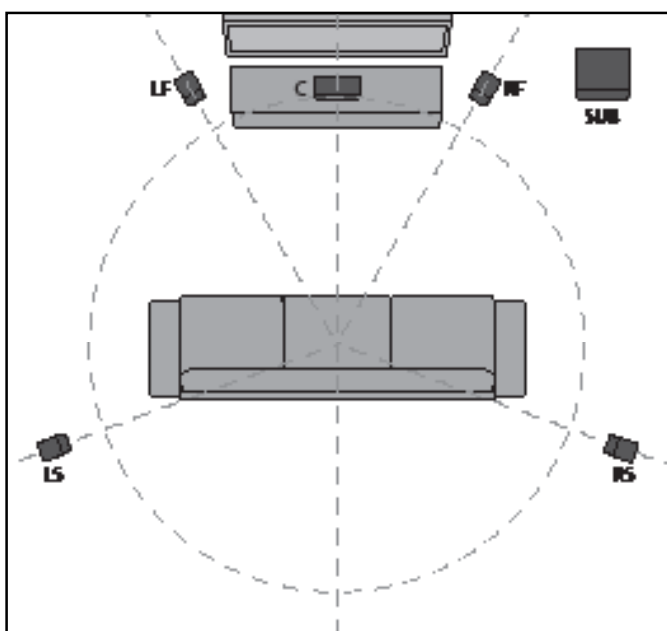

### 5.1 HOME THEATER SYSTEM

In a 5.1 home theater system, the center channel (C) should be placed at 0° directly below or above the video screen, the left front (LF) and right front (RF) speakers should be placed at 30° from the listening area, and the left and right surrounds (LS and RS) should be placed at 110°. All five speakers should be placed at or near ear level.

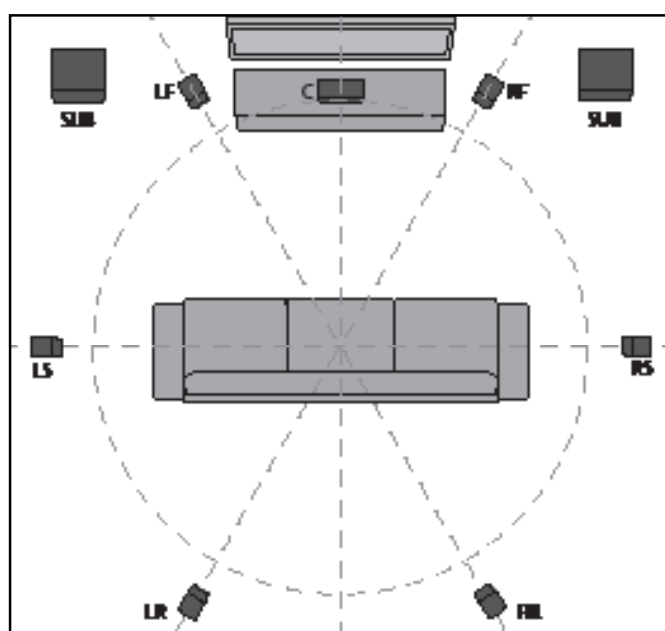

### 7.2 HOME THEATER SYSTEM

In a 7.2 home theater system, the center channel (C) should be placed at 0° directly below or above the video screen, the left front (LF) and right front (RF) speakers should be placed at 30° from the listening area, and the left and right surrounds (LS and RS) should be placed at 90°. The left rear (LR) and right rear (RR) speakers (sold separately) should be placed at 150°. All seven speakers should be placed at or near ear level.

### [SUBWOOFER PLACEMENT]

Subwoofer placement is less critical, because the frequencies they reproduce are omni directional. This means the human ear doesn't perceive these low frequencies as coming from a specific direction, enabling placement of a subwoofer virtually anywhere in the listening room.

It's best, however, to keep a subwoofer within the sound field of the other speakers. The closer the subwoofer is to a wall, the louder and more intense its bass output will be: this effect is even stronger when the sub is placed in or near a room's corner. If using two subwoofers, start by placing them next to the front left and right speakers, in both front corners or one in the corner and one 1/3 of the way along the front wall from the corner. Each room is different. Experiment with these options or try other locations until you get the best results. If you must choose a less-than-ideal position, the output level of Phase Technology powered subwoofers is adjustable to compensate for your listening environment.

## [SPEAKER CONNECTIONS]

The following instructions apply whether you are using a separate amplifier or Home Theater receiver. For simplicity we will use the term “amplifier” throughout this manual to mean both.



### Special note: Turn off and unplug your amplifier before connecting speakers. Special Note: Observe Speaker Polarity Carefully!

Every cable, speaker and amplifier is clearly marked to show their positive (+) and negative (-) terminals. Amps and speakers may use some combination of these symbols and/or colors to indicate positive (usually red) and negative (usually black or white) connections. One strand of your cable will also be ridged and/or marked with a colored line or other indicator on the positive side. For proper polarity and, thus, ideal system performance, always connect the positive side of the cable to the positive terminals on your speakers and amplifier and the negative side of the cable to the negative terminals.

**FRONT SPEAKERS:** The pair of front speaker connections (left and right) on your amplifier will be labeled “Front” or “Main.” Connect the speaker cables for your left and right front speakers using these terminals and then connect the cables to the front satellites. Observe positive and negative polarities.

**CENTER SPEAKER:** The center speaker connections on your amplifier will be labeled “Center” or “Center Channel.” Connect the speaker cables for your center channel speaker using these terminals and then connect the cables to the center speaker. Observe positive and negative polarities.

**SURROUND SPEAKERS:** The pair of surround connections (left and right) on your amplifier will be labeled “Surround.” Connect the speaker cables for your left and right surround speakers using these terminals and then connect the cables to surround satellite speakers. Observe positive and negative polarities.

**REAR SPEAKERS (OPTIONAL PURCHASE):** The pair of rear connections (left and right) on your amplifier will be labeled “Rear.” Connect the speaker cables for your left and right rear speakers using these terminals and then connect the cables to the rear satellite speakers. Observe positive and negative polarities.

**6.1-7.2 AND ADDITIONAL SUBWOOFERS:** Individual CineMicro One satellite speakers and subwoofers are offered separately. One or two extra satellites can expand your 5.1 system into a 6.1 or 7.1 system. Adding an extra subwoofer will expand your system to a 5.2, 6.2, or 7.2 system. Ask your Phase Technology dealer for details.

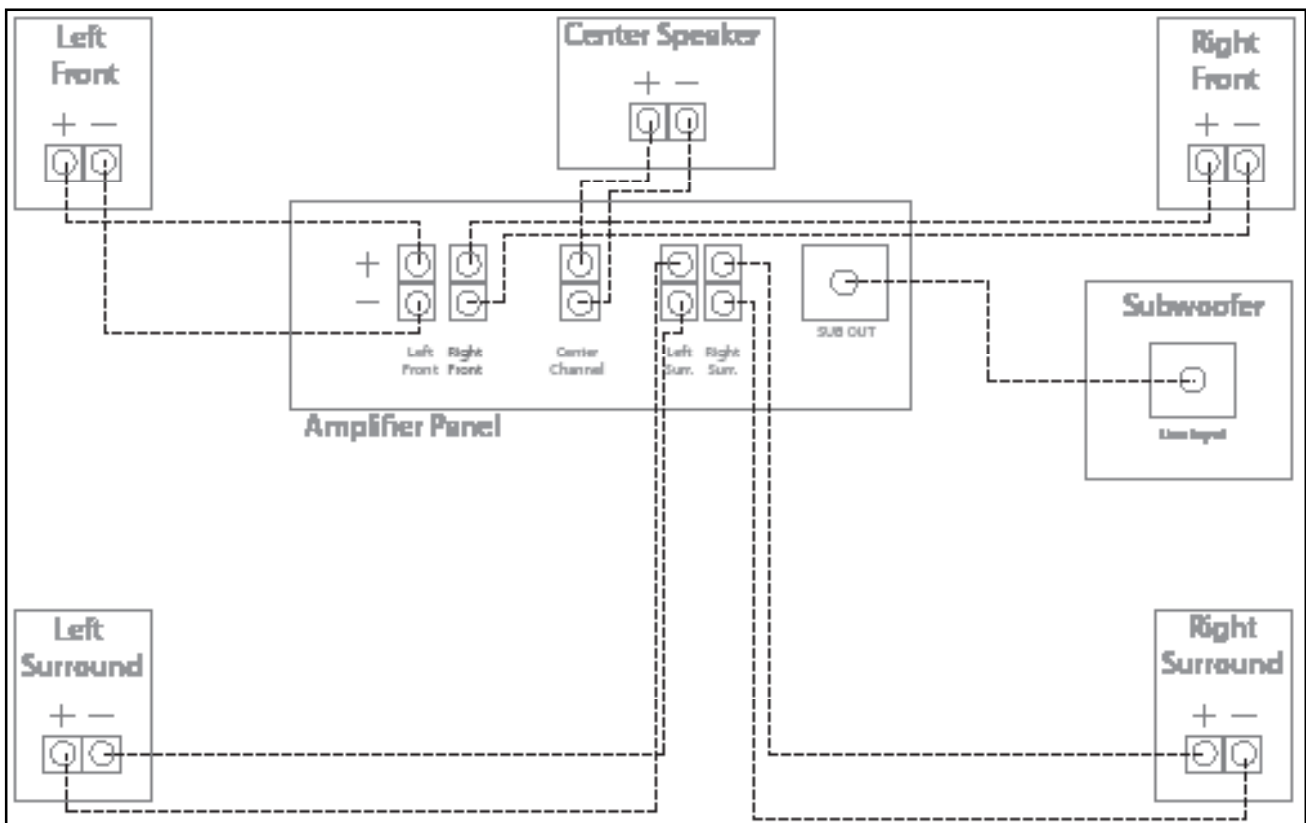

## [MOUNTING THE CINEMICRO® ONE ON A WALL]

The four satellites and center channel include keyhole-style inserts for on-wall mounting. Use an 8 mm screw in a drywall anchor capable of holding 2-3 times the weight of the speaker in the location you wish to mount the speaker. Leave the screw head about 1/4" out of the anchor, then slide the keyhole insert over the screw. Additionally, the four satellite and one center channel speakers feature M5 (5 mm) threaded inserts mounted on the rear or bottom of the speakers for use with standard wall mounting brackets (available from third party vendors).

## [TABLE TOP OR SHELF PLACEMENT]

Included with your CineMicro® speakers are self adhesive bumpers that can be used on the bottoms of the speakers to protect the finish when placing it on a shelf or table top. Simply peel off four of the bumpers from the backing paper and apply the four bumpers to the bottoms of each of the satellite speakers. To keep the center channel speaker from rocking and to level the speaker, two angled plastic feet are included that can be attached to the bottom of the speaker cabinet. Use two supplied screws to attach the feet to the left and right threaded inserts in the bottom of the cabinet. Two extra bumpers are also included to apply to the bottom of the speaker to protect the finish of the cabinet.

## [SUBWOOFER CONNECTIONS]

**OPTION 1: LOW LEVEL SETUP** This is the recommended method for those amplifiers and receivers that are equipped with a "Subwoofer Out" or "Pre-Amp Out" connection. Virtually all audio/video receivers have this connection clearly marked on the rear panel. Run a dedicated interconnect cable with RCA connectors from the subwoofer output jack to the line input on the subwoofer. In this setup, you will be using the internal crossover on your processor.

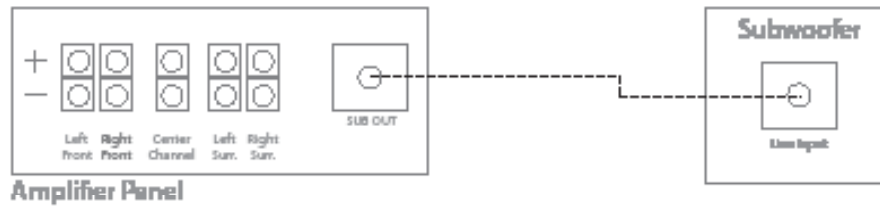

**OPTION 2: HIGH LEVEL INPUT SETUP** If your amplifier or receiver does not have a dedicated subwoofer output, it will be necessary to connect your new subwoofer directly to the speaker output terminals on the back of the unit. In this scenario, you will be running high quality speaker wires from the left and right front outputs of your amplifier to the high level inputs on the subwoofer. You will then need a second set of wires to carry the signal from the subwoofer back to the main speakers.

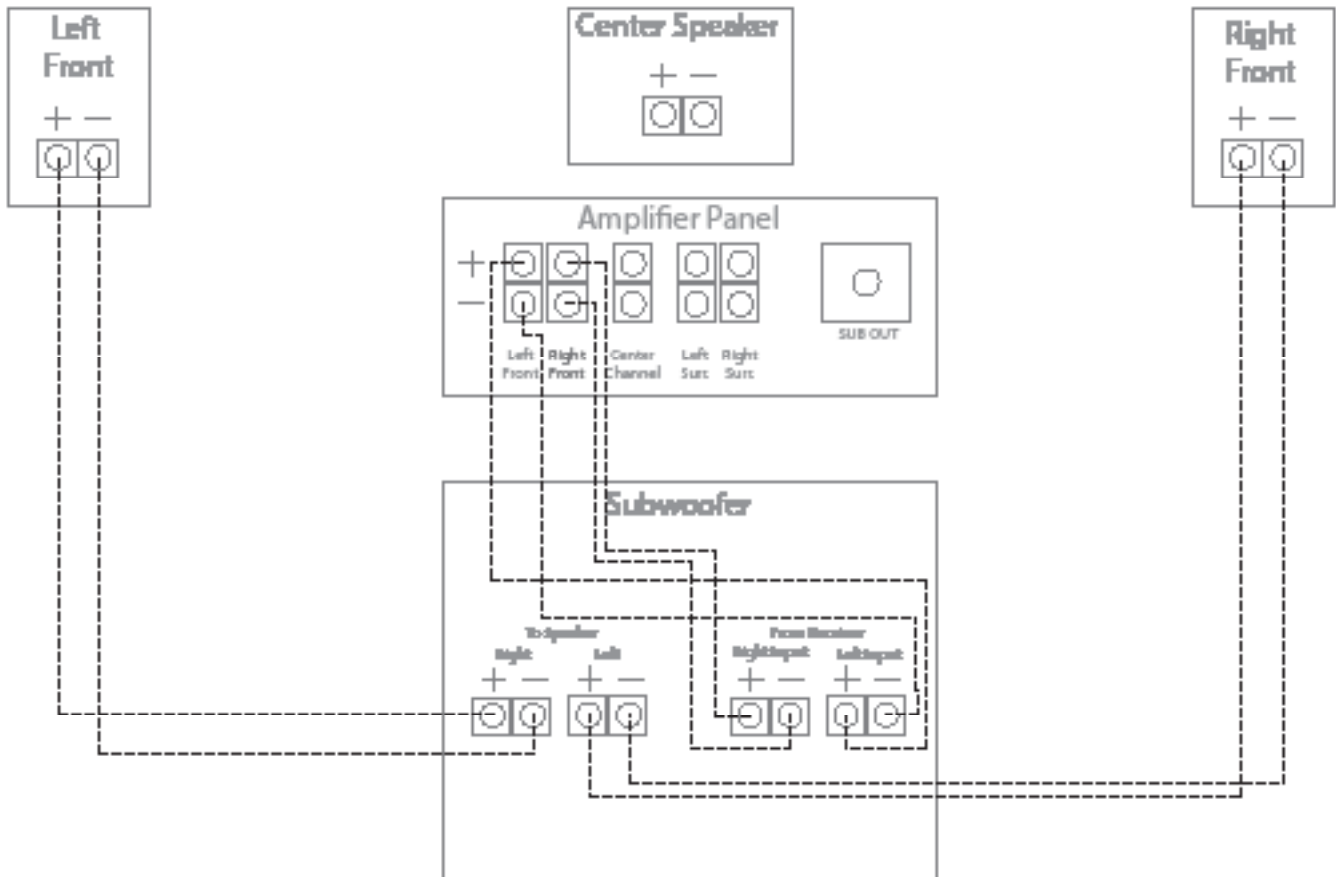

## [AMPLIFIER SETUP AND BASS MANAGEMENT]

Many home theater receivers/processors have a feature that controls how the bass is processed and delivered to the subwoofer. It also adjusts the amount of bass that is sent to your satellite speakers. Look carefully in your amplifier or receiver's instruction manual for details on how to adjust for the speaker size (sometimes called "Speaker Setup") for your system.

When using a Dolby Digital or DTS-capable receiver/processor with the subwoofer connected to the subwoofer out on your amplifier turn the "LOW-PASS FREQUENCY" control to the highest setting (200 Hz) on the back of your subwoofer. Set the subwoofer crossover setting in the speaker setup section of the amplifier setup menu to 150 HZ (or the next highest setting) and set the Satellites and Center channels to "small".

If you are NOT using the receiver's internal processor for subwoofer control then turn the "CROSSOVER FREQUENCY" control on the subwoofer to the 3 o'clock (150 Hz) setting.

## [SUBWOOFER AMPLIFIER PANEL]

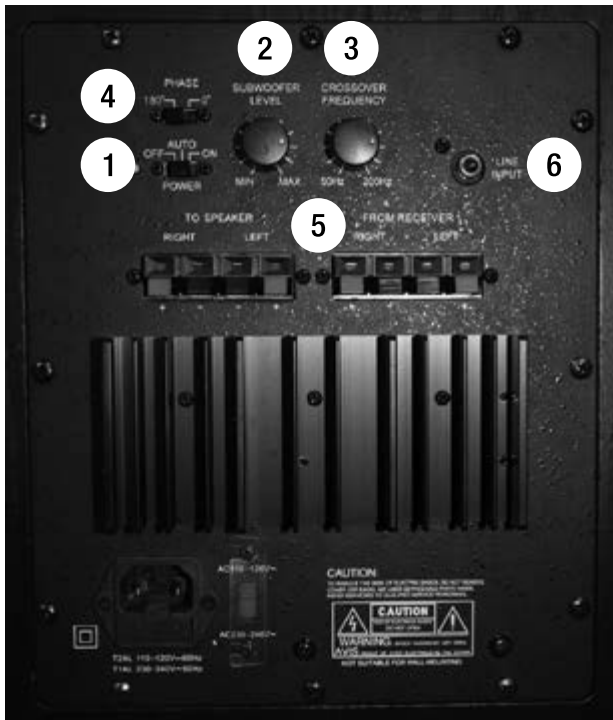

1. **Power ON/Auto/OFF:** This switch, when left in the "Auto" position, automatically activates the subwoofer when an audio signal is detected and shuts the subwoofer off after approximately ten (10) minutes of silence.

2. **Subwoofer Level Control:** Adjusts the volume of bass energy allowing you to customize overall tonal balance to your individual room acoustics and personal taste.

3. **Crossover Frequency Control:** This adjustment varies the point at which the subwoofer takes over the task of creating low bass frequencies from the rest of the audio signal permitting additional fine tuning of the total system. A little experimentation with this control will allow you to match the performance of the subwoofer to the rest of your speakers resulting in extraordinary, accurate, deep bass response. This control should be turned to its highest setting when the sub is connected through the Subwoofer out on your receiver.

4. **Phase Control:** This adjustment matches the phase - the in and out movement of speaker cones - to that of your main speakers. Adjust this control by listening to music with bass content. The setting is correct when the bass sounds the fullest.

5. **High Level Input and Output:** Used for direct speaker connections from the left and right front speaker outputs when a low-level subwoofer output is not available.

6. **Low Level Input:** Used from pre-out or Subwoofer-out.

## [CARING FOR YOUR PHASE TECHNOLOGY SPEAKER]

All Phase Technology speakers are finished with a high degree of craftsmanship in either hand polished paint or vinyl laminates. We recommend using a lint-free rag with a small amount of glass cleaner to maintain the long-lasting beauty of the finish. Avoid products containing silicones, oils, oil derivatives, or solvents. Enclosures finished in vinyl laminates may be cleaned with a damp cloth as necessary.

## [MAINTENANCE AND SERVICE]

Because of Phase Technology's uncompromising quality control programs, it's unlikely that your speakers will ever need service if connected and used as outlined in this Owners' Manual. In the unlikely event that a problem does occur, please contact your Phase Technology dealer. Your dealer has the necessary factory-authorized parts and trained technicians to quickly restore your speaker to its original performance specifications.

## [TROUBLESHOOTING]

### NO SOUND

1. Verify that all components are plugged in and turned on.
2. Check all speaker wires and cables for loose connections.
3. Check to see if you have selected the proper source on your amplifier.

### VOICES DO NOT APPEAR TO COME FROM BETWEEN THE SPEAKERS / BASS RESPONSE IS WEAK

1. Verify that all speaker connections from the amplifier to the speakers are running PLUS+ to PLUS+ and MINUS- to MINUS-.
2. Check to see if there are any furnishings or plants that may be blocking the output of a speaker. Make sure nothing is directly in front of that speaker.



### **SOUND, BUT NO BASS (MOST LIKELY IN SYSTEMS WITH A SUBWOOFER)**

1. Verify that the subwoofer is plugged into an AC outlet and power is turned on.
2. Check that the speaker wire / cable going from the amplifier/receiver to the subwoofer is securely fastened.
3. Check the volume control of the subwoofer.
4. Refer to your amplifier/receiver manual to make sure you have adjusted its bass output properly.

### **MUDDY OR BOOMY BASS**

1. Check the volume control for the subwoofer. Excess volume can cause speakers to sound distorted and unnatural.
2. Try adjusting the crossover control on the subwoofer or the subwoofer setup on your receiver to a slightly lower frequency (example: reduce from 120 Hz to 80 or 60 Hz).
3. If the subwoofer or full size speaker is close to a corner, side or back wall, try moving it away from the wall. This may reduce the “boomy” bass considerably.
4. Bookshelf speakers placed in a semi-enclosed space or cabinet can artificially emphasize bass output. Reduce the bass control on your amplifier or move the speakers to the front of the cabinet. Alternatively, reposition the speakers to a more open location.

### **DISTORTED SOUND FROM THE SPEAKERS**

1. This problem is usually caused by setting the volume control too high. Reduce the amplifier/receiver volume to a lower level.
2. If noise and distortion are audible at higher volume levels, your amplifier may not be powerful enough. Consider upgrading to a unit with higher power.

*NOTE: Remember, even though your Phase Technology speakers can handle considerable power levels, ANY speaker if used improperly can be damaged. Consult your Phase Technology dealer for assistance in choosing a new amplifier or receiver.*

### **[WARRANTY]**

**LIMITED WARRANTY:** Phase Technology warrants its loudspeakers to be free from defects in material and workmanship for a period of ten (10) years for speaker product, limited lifetime for CI speakers, and three (3) years for the electronic components to the original purchaser. Purchase must be made from an authorized Phase Technology dealer.

This warranty does not cover service or parts to repair damage caused by misuse, abuse, damage while in transit, alterations, unauthorized repairs, failure to follow instructions, fire, flood or any other cause beyond the reasonable control of Phase Technology. Defects in speaker cabinets or grilles must be brought to the attention of your dealer immediately after purchase. This warranty will be void if the products' serial number has been altered or removed.

Should your Phase Technology product require service, please call the MSE Audio customer service department for a return authorization. All merchandise returned to Phase Technology without prior authorization will be refused. For your return authorization number, please call 855.663.5600 or email [sales@mseaudio.com](mailto:sales@mseaudio.com).

### **[SPECIFICATIONS]**

<b>CINEMICRO ONE SYSTEM</b>	
<b>Description:</b>	5.1 Ultra-Compact Home Theater System; Four (4) Satellite Speakers, One (1) Dual Woofer Center Channel, One (1) 8" Long Throw Subwoofer
<b>Tweeter:</b>	.75" patented soft dome
<b>Woofer:</b>	3" Poly w/ NBR Surround; 8" polypropylene
<b>Crossover Frequencies:</b>	110; 4 kHz
<b>Frequency Response:</b>	36 Hz - 20 kHz
<b>Sensitivity:</b>	86 dB
<b>Impedance:</b>	8Ω
<b>Weight:</b>	38.88 lbs.
<b>Finish Options:</b>	Gloss Black

Copyright © 2014 MS Electronics, LLC. All rights reserved. MSE Audio, Phase Technology and PhaseTech are registered trademarks and "Speakers for your Life" is a trademark of MSE Audio, Overland Park, Kansas USA. Phase Technology is part of MSE Audio®. [www.phasetech.com](http://www.phasetech.com).

MSE AUDIO [  **INDUCTION DYNAMICS**  **PHASE TECHNOLOGY**  *Rockistics*  **Solid Drive**  **SOUNDTUBE ENTERTAINMENT**  **SOUNDSPHERE LOUDSPEAKERS** ]  
[www.mseaudio.com](http://www.mseaudio.com) | 8005 W. 110th Street | Suite 208 | Overland Park, KS 66210 | p:913.663.5600 | f:913.663.3200